



Universidades Lusíada

Oliveira, Carlos Alberto Rego de
Gomes, José

Martins, Cecília Maria Alves Torres

Emergy evaluation of an open cycle gas cogeneration system

<http://hdl.handle.net/11067/2173>

Metadados

Data de Publicação 2016-04-15

Resumo The development of this work aimed the emergy evaluation of an open cycle gas cogeneration power plant. This study also sought to assess the emergy efficiency of the cogeneration process in question, and, in addition to the energy flows, the quantification of the flows of matter, services and information involved in the production of steam and electrical power. The obtained emergy table shows that the non-renewable resources are the main contributors to the total flow of emergy required by the s...

Palavras Chave Economia do ambiente

Tipo article

Revisão de Pares Não

Coleções [ULF-FET] IJEIM, n. 6 (2014)

Esta página foi gerada automaticamente em 2024-04-19T18:20:48Z com informação proveniente do Repositório

EMERGY EVALUATION OF AN OPEN CYCLE GAS COGENERATION SYSTEM

Carlos Rego de Oliveira

Centro Lusíada de Investigação e Desenvolvimento em Engenharia e Gestão Industrial
Universidade Lusíada de Vila Nova de Famalicão, Portugal
Lcarego@fam.ulusiada.pt

José Gomes

Centro Lusíada de Investigação e Desenvolvimento em Engenharia e Gestão Industrial
Universidade Lusíada de Vila Nova de Famalicão, Portugal
josempgomes85@gmail.com

Cecília Martins

Centro Lusíada de Investigação e Desenvolvimento em Engenharia e Gestão Industrial
Universidade Lusíada de Vila Nova de Famalicão, Portugal
cmartins@fam.ulusiada.pt

Abstract: The development of this work aimed the emergy evaluation of an open cycle gas cogeneration power plant. This study also sought to assess the emergy efficiency of the cogeneration process in question, and, in addition to the energy flows, the quantification of the flows of matter, services and information involved in the production of steam and electrical power. The obtained emergy table shows that the non-renewable resources are the main contributors to the total flow of emergy required by the system, and renewable resources are the ones that contribute the least to the emergy of the system. Results indicate that the process has a considerable dependence on economic resources and the energy producer is harmed when selling energy because he gives more emergy than that he receives from money. Results also show that the process has a large dependence on the non-renewable resources, and therefore is not sustainable in the long term, from the standpoint of emergy.

Key-words: Cogeneration, energy, emergy evaluation.

1. Introduction

Nowadays, to meet the requirements of sustainable development, the evaluation of a production system needs to consider, not only energy, material, and economic analysis, but also an integrated analysis of environmental impacts and economic benefits (Sha e Hurme, 2012). The emergy analysis is one integrated evaluation method for ecological-economic systems that has been successfully applied to systems of different scales, including energy generation systems. The emergy analysis differs from standard energy analysis in that has wider boundaries and considers not only energy and material flows directly connected to the process, but also materials and services from the economy and the contribution of the environment.

Emergy is defined as the available energy of one kind, previously used up directly or indirectly to make a product or service (Odum, 1996). Emergy analysis is grounded in thermodynamic laws and general system theory and express all the process inputs (such as energy, natural resources and services) and outputs (products or services) in the emergy unit, the solar energy joules, solar emjoules, abbreviated seJ.

Emergy is in fact a measure (a “memory”) of how much work the biosphere has done to provide a product. Therefore emergy analysis is a method for assessing the performance of a system on the larger time and space scales of biosphere. Emergy analysis uses several indices to describe a system and to evaluate its sustainability (Brown and Ulgiati, 1997).

Heat and power are the main energy inputs for industries and human daily life, which affect the economic and social activities. Combined heat and power (CHP) generation processes have been considered worldwide a major alternative to traditional power systems because of their higher total efficiency than conventional power plants, typically 85% against 60% (Frangopoulos and Ramsay, 2001), and consequent reduction of greenhouse gas and other pollutants, provided the heat produced can be utilized for heating applications.

Several emergy based evaluation of energy generation systems, including CHP systems have been recently done worldwide. Brown e Ulgiati (2002) compared in detail three renewable electricity production methods (wind, hydro, geothermal) with three fossil fuel fired power plants (oil, coal and methane). Caruso (2001) compared a number of cogeneration technologies with conventional power plant technology. Peng *et al.* (2008) used emergy to evaluate three operation modes of a coal-fired CHP plant in Shandong China. Sha e Hurme (2012) used emergy analysis to compare two biomass and two coal-based CHP power plants. Buonocore *et al.* (2011) also analyzed a biomass based CHP system. Bargigli *et al.* (2010) used emergy to evaluate three natural gas CHP processes (gas turbine, internal combustion engine and a fuel cell hybrid system).

The present work purposes to do an emergy evaluation of an gas based cogeneration power plant, used in a Portuguese industry. The steam produced by the plant is used in the industrial complex which integrates the cogeneration power plant and most of the electricity produced is injected into the national electrical network. This is the first emergy evaluation of an energy generation system done in Portugal, and another goal of the work is to promote this analysis method.

2. Emergy methodology

To convert all different flows of a system to solar emjoules the emergy methodology uses Unit Emergy Values (UEVs). These are quantities by which the inputs flows of entries are multiplied to obtain their assigned emergy. There are three main types of UEVs (Brown and Ulgiati, 2004), as follows:

Transformity, defined as the emergy input per unit energy of available energy output. For example, if 10,000 solar emjoules are required to generate a joule of wood, then the solar transformity of wood is 10,000 solar emjoules per joule (seJ/J). The solar transformity of the sunlight absorbed by earth is 1.0 by definition.

Specific energy, defined as the energy per unit mass output, usually expressed as solar energy per gram (seJ/g). Material resources may best be evaluated with data on emergy per unit mass. As energy is required to concentrate materials, the unit energy value of any substance increases with concentration. Elements and compounds not abundant in nature therefore have higher emergy/mass ratios when found in concentrate form since more work was required to concentrate them, both spatially and chemically.

Emergy per unit money, defined as the emergy supporting the generation of one unit of economic product (currency). It is used to convert money payments into emergy units. It's a measure of the purchasing power of the real wealth of money for an economy in a given year. An average emergy/money ratio in solar emjoules/unit cost (seJ/\$) can be calculated by dividing the total emergy use of a state or nation by its gross economic product. This emergy/money ratio is useful for evaluating service inputs given in money units where an average wage rate is appropriate.

Empower is a flow of emergy (i.e., emergy/unit time). Emergy flows are usually expressed in units of solar empower (solar emjoules/time: seJ/s, seJ/year).

Emergy methodology procedures are described in Odum (1996) and consist of the three main following steps:

Energy systems diagramming. The diagramming defines the system boundary, as well as inputs and outputs that cross the boundary. The principal components within the boundary (materials, energy sources, stocks) and processes (flows, relationships, interactions, production and consumption processes, and so on) should be described. Flows and transactions of money believed to be important must be included.

Emergy evaluation table. Raw data on inflows that actual cross the boundary (of materials, energy and services) are converted into emergy units and then summed to obtain total emergy supporting the system.

Emergy indices evaluation. Emergy indices of a given system, calculated from the emergy evaluation table are shown to be functions of renewable, non renewable and purchased emergy inflows. The aggregated system diagram in figure 1 shows non-renewable environmental contributions (N), renewable environmental inputs (R), inputs from the economy as purchased goods and services (F), and Y as the yield.

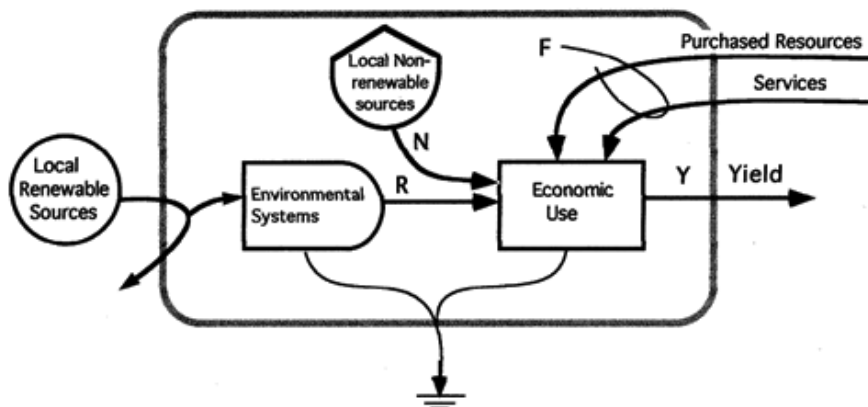

Figure 1 - Aggregated diagram of energy flows. Interface between use of the economy and of the environment (Brown and Ulgiati, 1997).

The total energy investment in the process is the sum of the energy required by all input flow (expressed in seJ):

$$Y = R + N + F \text{ (seJ)} \tag{1}$$

The transformity of a system product is defined by the ratio between the energy required to do it (Y) and its available energy (E):

$$Tr = \frac{Y}{E} \text{ (seJ/J)} \tag{2}$$

Transformity (as other UEVs) can be seen as a measure of the production efficiency of a process or system.

Several energy indices, given in table 1, based on energy evaluations of processes and economies are suggested (Odum, 1996; Brown and Ulgiati, 1997) to evaluate their net contributions and their relative sustainability for the future. The description of each one follows.

Table 1 - Main energy indices and calculation formulas.

Name and abbreviation	Formula
Renewability (REN)	$REN \% = (R/Y) \times 100$
(Energy yield ratio (EYR))	$EYR = Y/F$
Energy investment ratio (EIR)	$EIR = F/(R + N)$
Energy Exchange Ratio (EER)	$EER = Y/Y_m$
Environmental loading ratio (ELR)	$ELR = (F + N)/R$
Energy sustainability index (EmSI)	$EmSI = (EYR)/(ELR)$

Ym - Emergy corresponding to the money received in a trade. It is obtained multiplying the money received by the emergy/money ratio of the country.

REN % - Is the percent of the total emergy driving a process that is derived from renewable sources. It represents a first measure of system sustainability: the lower the fraction of renewable used, the higher the pressure on the environment. In the long run, only processes with high values of this index are sustainable.

EYR - Is an indicator of the yield compared to inputs other than local and gives a measure of the ability of the process to exploit environmental resources.

EIR - Is the ratio of emergy fed back from the outside of the system to the indigenous emergy input (both renewable and non-renewable). It gives an evaluation if the process is a good user of the emergy that is invested, in comparison with alternatives.

ELR - Is the ratio between non-renewable and imported emergy to renewable emergy used, it can be considered as a measure of ecosystem stress due to production activity.

EmSI - Is the ratio of the emergy yield ratio to the environmental loading ratio. It measures the potential contribution of a resource or process to the economy per unit of environmental loading.

EER - Is the ratio of emergy exchanged in a trade or purchase (what is received to what is given). The ratio is always expressed relative to one or to the other trading partners and is a measure of the relative trade advantage of one partner over the other.

To evaluate a system producing two simultaneous and inseparable products (co-products) in an emergetic perspective, such as electricity and heat (by steam) in a cogeneration system, Bastianoni and Marchettini (2000) introduced two transformity definitions, designated "joint transformity" and "weighted average of transformities" in order to compare the emergy efficiency of alternative processes and compare the emergy required in the co-production process to the total emergy required in independent production. The joint transformity, Tr_j , is set for a cogeneration system to produce electricity and steam (figure 2), as the ratio between the total emergy required by the system, Em_{cog} , and the sum of the energy content of electricity and steam, E_e and E_s respectively:

$$Tr_j = \frac{Em_{cog}}{E_{e,cog} + E_{s,cog}} \quad (3)$$

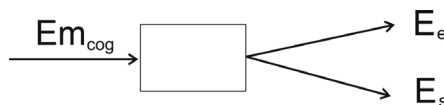

Figure 2 - Diagram for the definition of joint transformity.

The weighted average of transformities, Tr_{ave} , is the ratio of the sum of the energies required to produce power, Em_e and steam, Em_s , independently and the sum of the energy content of each one, E_e e E_s respectively (figure 3):

$$Tr_{ave} = \frac{E_e}{E_e + E_s} Tr_e + \frac{E_v}{E_e + E_s} Tr_s = \frac{Em_e + Em_v}{E_e + E_s} \quad (4)$$

where Tr_e and Tr_s are the transformities of the electricity and steam produced independently.

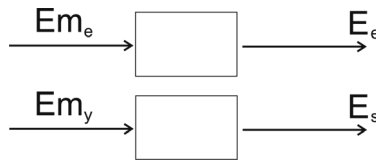

Figure 3 - Diagram for the definition of the weighted average of transformities

To compare these two transformities the produced quantities of electricity and steam must be the same in cogeneration and in independently processes and both based on the same fuel. Co-production is more efficient if the joint transformity Tr_j is smaller than the weighted average of transformities, Tr_{ave} . This comparison is analogous to that is normally done in energetic terms.. (Frangopoulos and Ramsay, 2001).

3. The gas CHP plant

This work was carried out in a company based in Portugal, which produces electricity and steam using a cogeneration system with open cycle gas turbine. The system under study (figure 4) allows the production of water vapor, which is sold to another company and, simultaneously, the production of electricity for consumption of the cogeneration system, and for sale to the national grid. The main components of the system are the generator (gas turbine, reducer box and alternator), boiler and central of lifting gas pressure to power the turbine.

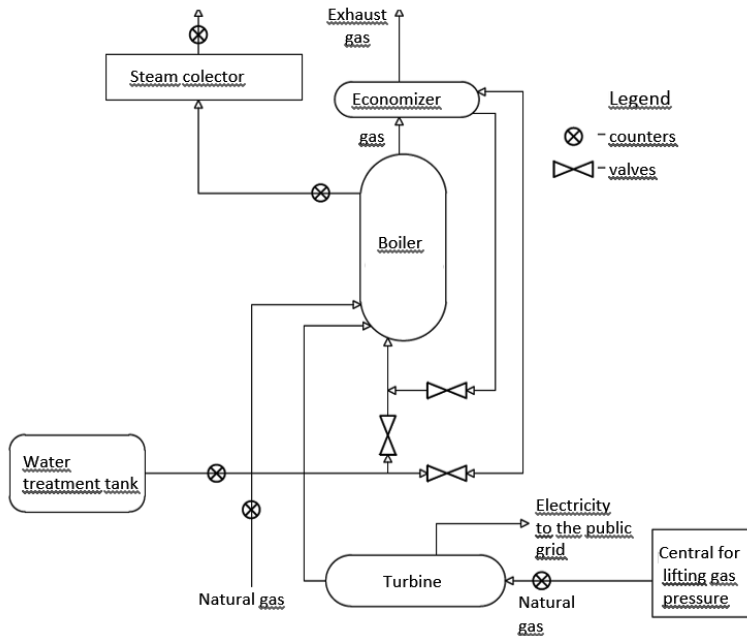

Figure 4 – Process diagram of analysed gas CHP power plant.

The turbine converts the chemical energy of fuel into mechanical energy. The alternator, added to the turbine through a reduction gear has an output of approximately 5MW of electricity. Almost all of this energy is sold to the grid, being a small part for the consumption of the own system. The turbine consumed 12.3293 million Nm³ of gas in the year 2010. The turbine has an air inlet at room temperature, which provides the required flow for combustion and cooling system. The steam is produced in the boiler taking advantage of the hot gases coming from the turbine to vaporize the water circulating in the tubes inside the boiler. To increase the thermal energy available for production of steam, the boiler is also feed with a small quantity of combustion gas. The steam leaves the boiler plant at a flow rate of 15,590 kg/h. In 2010 the cogeneration system produced 127.27 million of kg of steam.

4. Results and discussion

4.1 Energy system diagram

The energy diagram of the CHP system studied is shown in Figure 5. The system inflows (flows of energy, matter and services) are related to all resources that cross the border and that are necessary for the production of electricity

and steam. The outflows (steam, electricity and exhaust gases) are a result of the interactions of the various resources within the system. The resources are accounted in units of energy, mass or currency. For a better understanding of existing flows in the diagram, energy and materials flows are represented with solid lines and the flows of currency with dashed lines. The thin dashed lines going out to the bottom of the diagram are related to existing power losses in each component of the system.

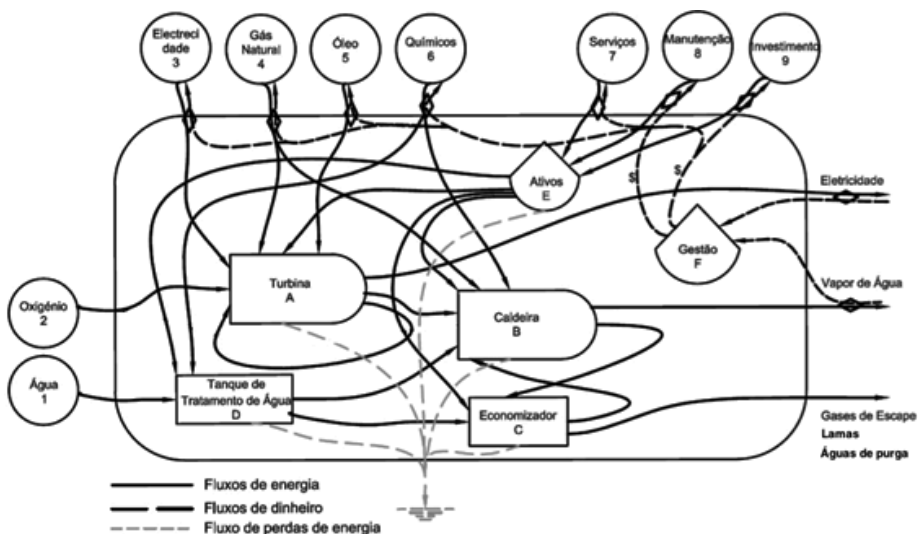

Figure 5 - Gas CHP energy system diagram.

The turbine (A) and the boiler (B) are the components that need more resources. In the case of the turbine (A), the resources essential to its operation are the oxygen, natural gas, electricity, lubricating oil and economic resources. The boiler (B) needs water, gas, chemicals and economic resources. The tank of water treatment (D) and the economizer (C) are essential components for the operation of the boiler, because these are the water suppliers. In the water treatment tank (D) chemicals are used to reduce the amount of salts entering into the boiler. The economizer (C) uses the treated water and hot gases from the boiler to provide pre-heated water for the boiler. The economy's resources are managed by assets (E) that make the distribution of services, maintenance and investment for the various system components. Input and output money flows are controlled by management (F).

4.2 Energy and emergy accounting

Based on the flows of the system, an emergy table was formed (Table 2). The input flow concerning the construction and implementation of the system

was considered only based in its cost, quantified in euros. In addition the quantification of the components used in the construction phase in terms of units of mass (kg) and energy (J) would allow a more complete analysis, but there were no data available for that. It was considered that the value of investment is amortized in 20 years, a life time period typical of a cogeneration power plant of this type. Data relating to the operational phase of the system in the year 2010 were considered. All flows were converted to units of energy (J), mass (g) or currency (€), per year (column 4) and then multiplied by the corresponding unit energy values, UEV (column 5), to obtain the respective flows of energy for that year of production. UEV's values were obtained The graph in Figure 6 shows the relative contribution of all system resources from the respective values of energy flow required to obtain the final products (electricity and steam). From Table 2 and Figure 6 it can be seen that the most influential resource in the cogeneration system under study is the consumed natural gas (59,6%, being 49.3% in the turbine and 10.3% in the boiler), followed by services (30,9%, being 26,8 % related to consumption of gas), and then the oxygen and the investment with lower contributions (8.38% and 2.4% respectively). The remaining resources contribute little to the total energy flow required (water with 0.31%, labor with 0.74%, lubricating oil with 0.01% and energy contracted with 0.004%), although they are obviously essential for running the system.

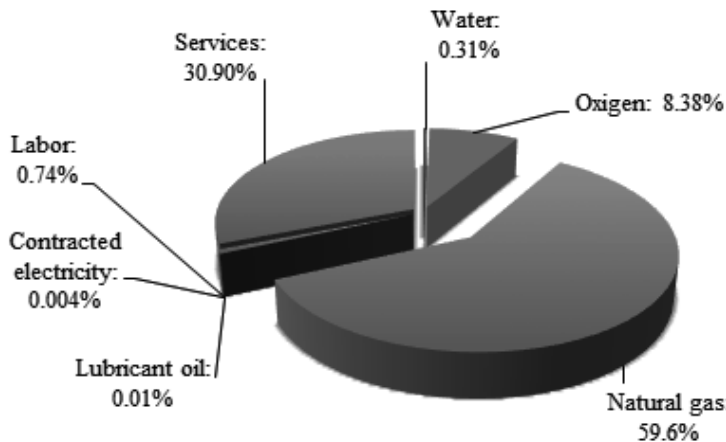

Figure 6 – Input energy flows of the CHP system (percent values).

Table 2 shows that 1.39×10^{14} J of electricity and 3.48×10^{14} J of heat were produced in the year 2010, and the energy consumed from gas was 5.64×10^{14} J. The energetic efficiencies and the work-heat ratio calculated from these values are shown in Table 3. The results are in agreement with typical values of this type of energy generation systems (Sá, 2008; Frangopoulos and Ramsay, 2001).

Table 3 - Energetic efficiencies for the natural gas CHP process.

<u>Electric efficiency</u>	<u>Thermal efficiency</u>	<u>Global efficiency</u>	<u>Heat-work ratio</u>
$\eta_{E,cog} = \frac{E}{C} \times 100$	$\eta_{Q,cog} = \frac{Q}{C} \times 100$	$\eta_{gl,cog} = \frac{E+Q}{C} \times 100$	$\gamma_{cog} = \frac{Q}{E}$
24,6%	61,7%	86,3%	2,5

Table 2 shows that the emergy required by the system in 2010 was 1.61×10^{20} seJ. The joint transformity, Tr_j , was calculated using equation (3), yielding the value of 3.31×10^5 seJ/J. To calculate the weighted average of transformities, Tr_{ave} , this work considered transformities of electricity and heat for independent productions from the literature, since it has not possible to calculate these transformities with the system studied. The value obtained was 1.45×10^5 seJ/J, which is less than the joint transformity, leading to believe that the independent production of both features is more profitable than the cogeneration production. This goes against energetic principles. The fact that it was not possible to calculate the transformities of electricity and steam produced independently in gas based systems and in the same production levels of the cogeneration system, should be the cause of this low value. The independent transformities should be higher than those considered.

4.3 Emergy indices

The emergy flows of the system were aggregated by category in order to determine the emergy indices, as mentioned earlier: renewable resources (R), non-renewable resources (N), economic resources (F) and products output (Y). The comparison between the emergy flows of aggregated resources is made in the bar graph of Figure 7. It can be seen that non-renewable resources are the most used, representing approximately 59.6% of the total emergy required to produce electricity and steam. These are composed of natural gas and the lubricant oil, this last having a very small contribution to the flow of this aggregate (0.01%), and, therefore, natural gas is the principal raw material of the system. The economy's resources (F) represent 31.68% of total inflows, while renewable resources (R) correspond to 8.69% of the total system needs. In the first case, the main component relates to services, which are essentially due to the cost of gas (84.51% of the aggregate flow), followed by the cost of investment (7.55%). The main component of renewable resources is the oxygen used to aid combustion (96.43% of this flow), the other being the water with a very small contribution (0.57%).

Table 2 – Energy analysis of the cogeneration power plant.

No.	Item	Unit (J, g or €)	Flow (unit/ year)	UEV (sej/unit)	Ref ^a	Energy flow (sej/year)	% Energy flow	Flow type
Input flows								
Renewable resources								
1	Water	g	1,42E+11	3,54E+06	a	5,02E+17	0,31%	R
2	Oxygen	g	1,63E+11	8,30E+07	d	1,35E+19	8,38%	R
Non-renewable resources								
3.	Natural gas	J	5,64E+14	1,70E+05	c	9,60E+19	59,63%	N
3a	Natural gas for turbine	J	4,67E+14	1,70E+05	c	7,95E+19	49,32%	N
3b	Natural gas for boiler	J	9,70E+13	1,70E+05	c	1,65E+19	10,25%	N
4	Lubricant oil	g	1,89E+06	6,22E+09	c	1,18E+16	0,01%	N
Resources from economy								
5	Contracted electricity	J	3,79E+10	1,68E+05	e	6,37E+15	0,004%	F
6	Labor	€	1,27E+05	9,35E+12	b	1,19E+18	0,74%	F
7	Services	€	5,33E+05	9,35E+12	b	4,98E+19	30,9%	F
7a	Maintenance (materials and labor)	€	2,65E+05	9,35E+12	b	2,47E+18	1,54%	F
7b	Chemicals	€	1,05E+04	9,35E+12	b	9,82E+16	0,06%	F
7c	Natural gas	€	4,61E+06	9,35E+12	b	4,31E+19	26,78%	F
7d	Lubricant oil	€	2,57E+04	9,35E+12	b	2,40E+17	0,15%	F
7e	Contracted electricity	€	2,44E+03	9,35E+12	b	2,28E+16	0,01%	F
7f	Investment	€	4,12E+05	9,35E+12	b	3,85E+18	2,40%	F
Output flows								
8	Heat (steam)	J	3,48E+14	$T_r = 3,31E+05$	f	1,61E+20	100,0%	Y
9	Electricity	J	1,39E+14	(sej/J)		1,61E+20	100,0%	Y

a – Buenfil (2001); b – Oliveira *et al.* (2012), c – Buonocore *et al.* (2011); d – Ulgiati e Tabacco (2002); e – average, this work; f – this work;

1 – Water quantity = $141.768.000 \text{ L/ano} \times 0,001 \text{ m}^3/\text{L} \times 1 \times 10^6 \text{ g/m}^3 = 141.768.000.000$

g/year

2 - Oxigen quantity = $(14.700 \text{ m}^3/\text{h} \times 8160 \text{ h}) \times 1,355 \text{ kg}/\text{m}^3 = 162.534.960 \text{ kg}$

3a - Energy of natural gas in turbine = $12.329.300 \text{ Nm}^3 \times 37.910.000 \text{ J}/\text{Nm}^3 = 4,674\text{E}+14 \text{ J}$

3b - Energy of natural gas in boiler = $2.559.597 \text{ Nm}^3 \times 37.910.000 \text{ J}/\text{Nm}^3 = 9,703\text{E}+13 \text{ J}$

4 - Oil quantity = $1.900 \text{ L} \times 0,9968 \text{ kg}/\text{L} \times 1000 \text{ g}/\text{kg} = 1.893.920 \text{ g}$

5 - Contracted electricity = $10.528 \text{ kWh} \times 3.600.000 \text{ J}/\text{kWh} = 3,79\text{E}+10 \text{ J}$

7f - Anual investment = $(7.542.352 \text{ €} / 20 \text{ anos}) + 9,326\% = 412.287,59 \text{ €}/\text{ano}$

9 - Electricity = $38.602.187 \text{ kWh} \times 3.600.000 \text{ J}/\text{kWh} = 1,39\text{E}+14 \text{ J}$

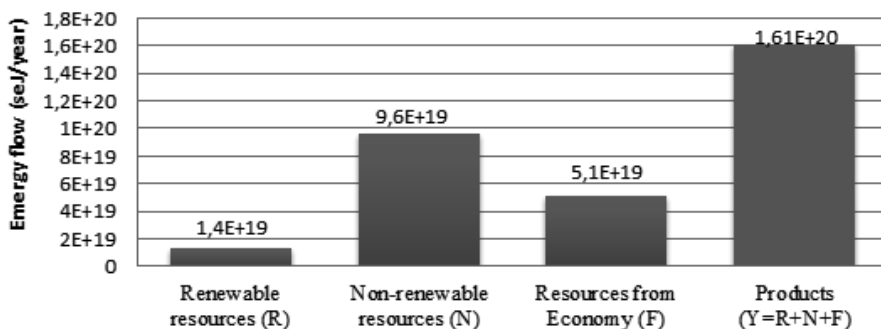

Figure 7 - Emergy flows associated with aggregated resources

The emergy indices calculated based on the aggregated emergy flows, as described earlier, are presented in Table 4.

The emergy yield ratio (EYR) was 3.16, slightly greater than unity, showing that the system is largely dependent on the resources of the economy. The low value obtained for the emergy investment ratio (EIR), of 0.46, indicates that the process does a good use of the economic resources in exploring environmental resources, renewable and nonrenewable, despite the high use of this type of resource. This means the process is, in principle, more able to compete in the markets, but this rate should be compared to alternative processes and this index must not be seen independently of the others.

Table 4 -Emergy indices for the gas based CHP system.

Index	EYR	EIR	ELR	EER	EmSI	REN %
Function	Y/F	F/(R+N)	(F+N)/R	Ym/Y	EmSI= EYR / ELR	(R/Y) × 100
CHP system	3,16	0,46	10,50	0,37	0,30	8,69%

The system under consideration has a value for the environmental load ratio (ELR) of 10.50, which is very high, indicating a large environmental stress.

This is due to a greater reliance on non-renewable resources (natural gas) and to a lesser degree, on resources from the economy, in detriment of renewable resources. The emergy exchange ratio (EER) has a value of 0.37, much lower than the unit, indicating that the producer of electricity and steam gets, by the money he receives, an amount of emergy less than the emergy associated with the products, so the exchange is unfavorable to the seller in emergy terms, i.e., in terms of the real value of their products. The sustainability index value (EmSI) is low, of 0.3, which is typical of processes that primarily depend on non-renewable resources. This value indicates that the contribution of the process to the economy, per unit of environmental load is low. This index also shows a weak dependence of the cogeneration plant on renewable resources, indicating a weak sustainability of the system. The value obtained for the emergetic renewability (Ren %) is also low, 8.69%, indicating that there is a greater reliance on non-renewable resources and resources of the economy, in detriment of renewable resources, suggesting that the system will not be sustainable in the long term. The contribution of renewable resources corresponds to the combustion oxygen necessary for the process.

4.4 Comparison with other works

The results presented above can be compared with those of some other authors. However we didn't find in the literature results for a natural gas CHP system of the same dimension and type and those we found do not present results for the same indices evaluated in this work. Other cogeneration systems present in the literature use biomass or coal as fuel. Most authors calculate the transformity of each co-product in CHP processes dividing the total emergy required by the system by its energy content. The authors of this study believe that this method of calculus of two separate transformities does not allow to compare the efficiency of different alternative cogeneration processes. So the transformities calculated by this way were not considered in this paper. The notion of joint transformity was recently introduced in emergy analysis and the work of Sha and Hurme (2012) is the only one found in literature that calculates this transformity for a CHP power plant system. The joint transformity value calculated in this work is approximately 10 times higher than those calculated by Sha and Hurme (2012) for biomass CHP process and 3 times higher than those of coal CHP process. In both works the ratio heat/work is the same (2.5). However, the energy produced by the systems studied by Sha and Hurme (2012) is three times higher than in this study. Anyway, results seem to indicate that the efficiency is higher in biomass CHP systems, followed by the coal CHP systems and then by gas CHP systems. As for the other indices, the values found in this work for the ELR index, EmSI and REN are similar to those calculated by the Sha and Hurme (2012) in coal CHP processes, but worse than the values obtained by Sha and Hurme (2012) and by Buonocore et al. (2011) for biomass CHP processes, since these indices relate directly to the use of renewable resources and the sustainability. The

calculated value for the EIR is lower than in other studies, indicating a better use of resources from the economy, but instead the EYR is higher, indicating a lower use of environmental resources (renewable and non-renewable) compared to economic resources.

5. Conclusion

In this study, a solar energy evaluation was carried out for a gas cogeneration power plant. The emergy analysis has highlighted the relative importance of each of the system resources and the relationships between them through the emergy indices calculated. The analysis determined indices that, on the one hand show that the system does a good use of economic resources, but on the other hand, indicate that its efficiency is inferior to coal and biomass cogeneration systems with which it was compared, and it is not sustainable in the long term. This is due to the fact that the main resource is non-renewable (natural gas). If the economy's resources can be reduced the emergy indices related to emergy efficiency and investment should improve. The analysis also highlighted that emergy sent on the sale of electricity and steam is greater than that received through money paid for them and so the trade is unfavorable for the producer in an energetic point of view, i.e., in the point of view of the real value of the products. For a more complete analysis the list of resources needed by the system should be improved and the values of transformities of heat and electricity in independent production should be obtained to be able to compare the mode of production in cogeneration with independent modes of production. This work shows that the emergy analysis allows to have a more complete picture of the system compared to usual energy and economic analyzes, in the sense that it integrates all types of resources, on a same basis, involved in the operation of the system. The emergy analysis is useful to better compare energy production systems of the same type and of different types. The emergy approach has been proved to be an efficient method for analyzing power plants from the large-scale and long-term sustainability point of view, since the emergy expresses how much work the biosphere has done to provide a product or service.

Acknowledgements

This work had the financial support of the Portuguese Foundation for the Science and Technology (FCT) through the Strategic Project - UI 4005 - 2014, Project Reference PEst-OE/EME/UI4005/2014.

References

- Bargigli, S., et al. (2010). Cogeneration of heat and electricity: A comparison of gas turbine, internal combustion engine, and MCFC/GT hybrid system alternatives. *Journal of Fuel Cell Science and Technology*, Vol. 7, pp.1-5.
- Bastianoni, S., Marchettini, N. (2000). The problem of co-production in environmental accounting by emergy analysis. *Ecological Modelling*, Vol.129, pp.187-193.
- Brown, M.T., Ulgiati, S. (1997). Emergy-based indices and ratios to evaluate sustainability: monitoring economies and technology toward environmentally sound innovation. *Ecological Engineering*, Vol. 9, pp.51-69.
- Brown, M.T., Ulgiati, S. (2002). Emergy evaluations and environmental loading of electricity production systems. *Journal of Cleaner Production*, Vol. 10, pp. 321-334.
- Brown, M.T., Ulgiati, S. (2004). Energy quality, emergy, and transformity: H. T. Odum's contributions to quantifying and understanding systems. *Ecological Modelling*, Vol.178, pp. 201-213.
- Buenfil, A. (2001). *Emergy Evaluation of Water*. Gainesville, USA: University of Florida, USA.
- Buonocore, E. et al. (2011). Emergy Evaluation of an Integrated Bioenergy Production System - The Case Study of Enköping (Sweden). In: *Proceedings of the Sixth Biennial Emergy Conference - Theory and Applications of the Emergy Methodology*. Gainesville, USA: University of Florida.
- Caruso, C. (2001). Emergy based analysis of Italian electricity production system. *Journal of Thermal Analysis and Calorimetry*, Vol. 66, pp. 265-272.
- Frangopoulos, Ramsay, B. (2001). *The European Educational Tool on Cogeneration*. 2ª edição.
- Odum, H. T. (1996). *Environmental accounting: EMERGY and environmental decision making*. New York: John Willey & Sons, Inc.
- Oliveira, C. et al. (2013). Solar Emergy Evaluation of Portugueses Economy. In: *Proceedings of the Seventh Biennial Emergy Conference - Theory and Applications of the Emergy Methodology*. Gainesville, USA: University of Florida.
- Peng, T. et al. (2008). Should a small combined heat and power plant (CHP) open to its regional power and heat networks? Integrated economic, energy, and emergy evaluation of optimization plans for Jiufa CHP. *Energy*, Vol. 33, pp. 437-445.
- Sá, A. F. R. (2008). *Guia de Aplicações de gestão de energia e eficiência energética*. Porto: Publindústria.
- Sha, S., Hurme, M. (2012). Emergy evaluation of combined heat and power plant processes. *Applied Thermal Engineering*, Vol. 30, pp. 1-8.
- Ulgiati, S., Tabacco, A. (2001). In: *Proceedings of the Second Biennial Emergy Conference - Theory and Applications of the Emergy Methodology*. Gainesville, USA: University of Florida.